

D2xB1LD2-H UL1971 Haz Loc Synchronized LED Light

The haz loc D2xB1LD2-H is an auto-synchronizing LED warning light / beacon tested to UL1971 suitable for public mode fire alarm, ADA compliant, hearing impaired applications. UL1971 effective candela rating of 38.38cd.

The D2xB1LD2-H utilizes an array of high power Cree® LED's, orientated to optimize visibility in any direction. Multiple D2xB1LD2-H units will auto-synchronize when powered from the same power source removing the need for any additional sync modules on the circuit. The D2xB1LD2-H contains a supervisory diode and duplicated pluggable terminals that not only simplify installation but also enable a 4 wire connection. The unit is UL, cUL & ULC approved for Class I Div 2, Class II Div 2, Class I Zone 2/22 as well as IECEx and ATEX certified for Zone 2 and 22 hazardous area applications.

Features

- Public mode fire use UL1971 & CAN/ULC-S526
- Synchronized for over 2 hours per UL1971
- 38.38 eff. candela - UL1971 Public mode fire
- 180 eff. candela - UL1638 general signaling
- Ultra low operating current of 99.5mA
- In rush limiting circuit <2A
- Choice of three flash rates: 1Hz, 1.3Hz, 2Hz
- Marine grade aluminum enclosure
- Ingress protection Type 4/4X/3R/13, IP66
- High impact resistant Borosilicate glass lens
- Duplicate, pluggable cable terminations
- Conduit mounting via integral 3/4" NPT entry
- Surface mounting via user installed lugs
- Dual 1/2"NPT and dual M20 entries
- Supplied with haz loc rated stopping plugs
- Compact footprint

Approvals

- UL/cUL File ref: E245313
- IECEx certificate: IECEx ULD 14.0004X
- ATEX certificate: DEMKO 14 ATEX 4786493904X
- CSFM listing: 7300-2279:0500

Coding

- NEC / CEC:
 - Class I Div 2 ABCD T4 Ta -40°C to +50°C
 - Class I Div 2 ABCD T4A Ta -40°C to +40°C
 - Class II Div 2 FG T6 Ta -40°C to +50°C
 - Class III Div 1 & 2 Ta -40°C to +50°C
- NEC:
 - Class I Zone 2 AEx nA IIC T4 Gc (Ta -40°C to +50°C)
 - Zone 22 AEx tc IIIC 75°C Dc (Ta -40°C to +50°C)
- CEC:
 - Class I Zone 2 Ex nA IIC T4 Gc X (Ta -40°C to +50°C)
 - Zone 22 Ex tc IIIC 75°C Dc X (Ta -40°C to +50°C)
- IECEx & ATEX:
 - II 3G Ex nA IIC T4 Gc (Ta -40°C to +50°C)
 - II 3D Ex tc IIIC 75°C Dc (Ta -40°C to +50°C)



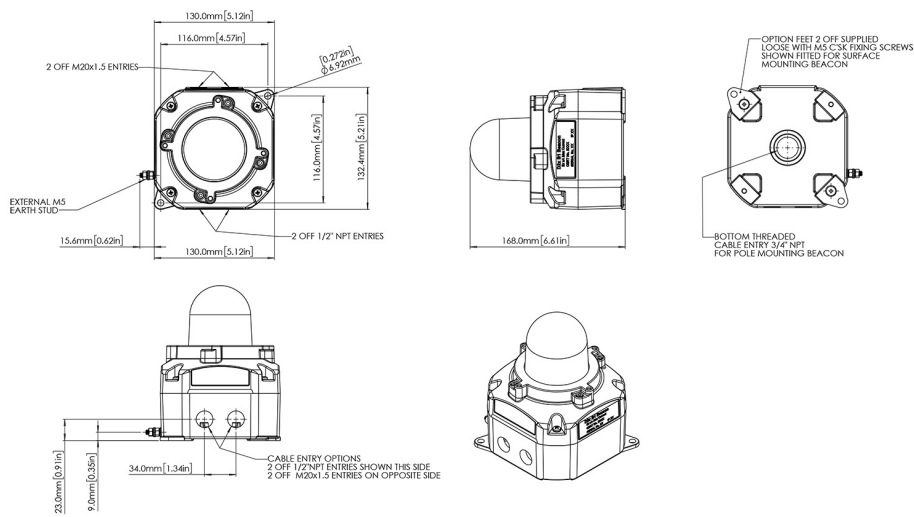

Specification

Source:	Array of 4 x High Power Cree® LED's
Modes:	1Hz flash (60 fpm) 1.5Hz flash (90 fpm) 2Hz flash (120 fpm)
Eff. Intensity cd:	38.38 cd UL1971 Public mode fire
Eff. Intensity cd:	180 cd UL1638 General signaling
Peak Intensity cd:	300,000 cd
LED life:	>60,000 hours
Synchronization:	Flash rates synchronize for a minimum of 2 hours per UL1971
Voltage:	24V dc (16-33V dc)
In-rush:	1.88A for 2ms
Ingress protection:	IP rating per EN60529:IP66 Type rating per UL50E/NEMA250:4/4X/3R/13
Enclosure material:	Marine grade LM6 aluminum alloy
Enclosure colour:	Red (RAL3000)
Lens material:	Borosilicate glass
Cable entries:	2 x M20x1.5, 2 x 1/2"NPT, 1 x 3/4"NPT
Stopping plugs:	Nickel Plated Brass plugs included
Ground/Earth stud:	M5
Terminals:	0.5 - 2.5mm ² (20-14 AWG)
Line monitoring:	Blocking diode included EOL can be factory fitted
Operating temp:	-40 to +50°C [-40° to +122°F]
Storage temp:	-40 to +70°C [-40° to +158°F]
Relative humidity:	95%
Weight:	1.5kg/3.31lbs

Part Codes

Part Code:	Ident.:	Description:
Product type:	D2xB1LD2	Haz loc LED warning light / beacon
Voltage:	DC024	24V dc (16-33Vdc)
Cable entries: [e]	M	2 x 1/2" NPT 2 x M20x1.5 1 x 3/4" NPT
Stopping plug material: [m]	B N S	Brass Nickel plated brass Stainless steel
Lens guard & tag: [s]	0 5	No lens Guard No lens guard with Equip. Tag
Version: [v]	H1	UL, cUL, IECEx & ATEX - UL1971
Enclosure: [x]	R	Red RAL3000
Lens colour: [y]	C	Clear
Accessories:	SP65-0001-A2 SP65-0001-A4 SP65-0002-A2 SP65-0002-A4	Pole Mount Bracket Kit 2" St/St A2 (304) Pole Mount Bracket Kit 2" St/St A4 (316) Sunshade - St/St A2 (304) Sunshade - St/St A4 (316)

Current Consumption

Nominal Voltage:	In rush:	Voltage range:	Flash Rate setting:	Nominal operating current:
24V dc	1.88A	Regulated 16-33V dc	1Hz (60fpm) 1.3Hz (80 fpm) 2Hz (120fpm)	99.5mA 104mA 103mA

Multi-function patterns

Stage 1: [On board]	Stage 2: [Remote]	Stage 3: [Remote]
Steady High Power	Flashing 1Hz †	Triple Strike
Steady Low Power	Flashing 1Hz †	Triple Strike
Flashing 1Hz †	2x Flash 2Hz	Triple Strike
Flashing 1.5Hz †	Flashing 2Hz †	Double Strike
Flashing 2Hz †	Triple Strike	Triple Strike
Double Strike	Steady High Power	Triple Strike
Triple Strike	Flashing 2Hz †	Double Strike

† Setting permitted for use as public mode fire alarm device